

**MATÉRIELS DE MANUTENTION  
ET D'ÉLEVATION**

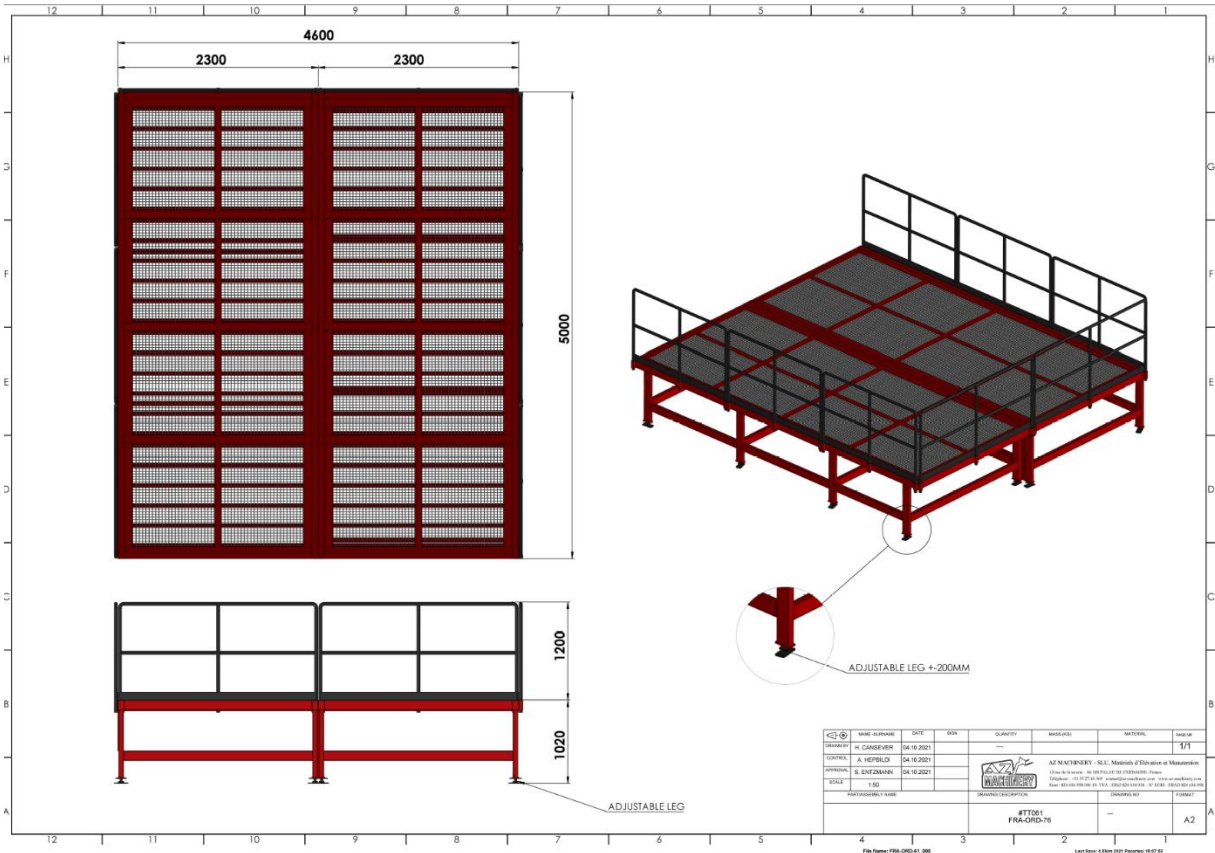

REV	DATE	BY	CHKD	QUANTITY	REVISION	REVISION	SCALE
01	04.10.2021	M. CARSEVER					1/1
02	04.10.2021	A. HEIBOLD					
03	04.10.2021	S. ENZMANN					
04	18.01.2022						

NO	DESCRIPTION	QUANTITY	UNIT
1	PLATEFORME	1	UNIT

  

#TT061	FRA-ORD-70		A2
--------	------------	--	----

File Name: FRA-ORD-41\_200

Last Save: 4 Oct 2021 10:07:52

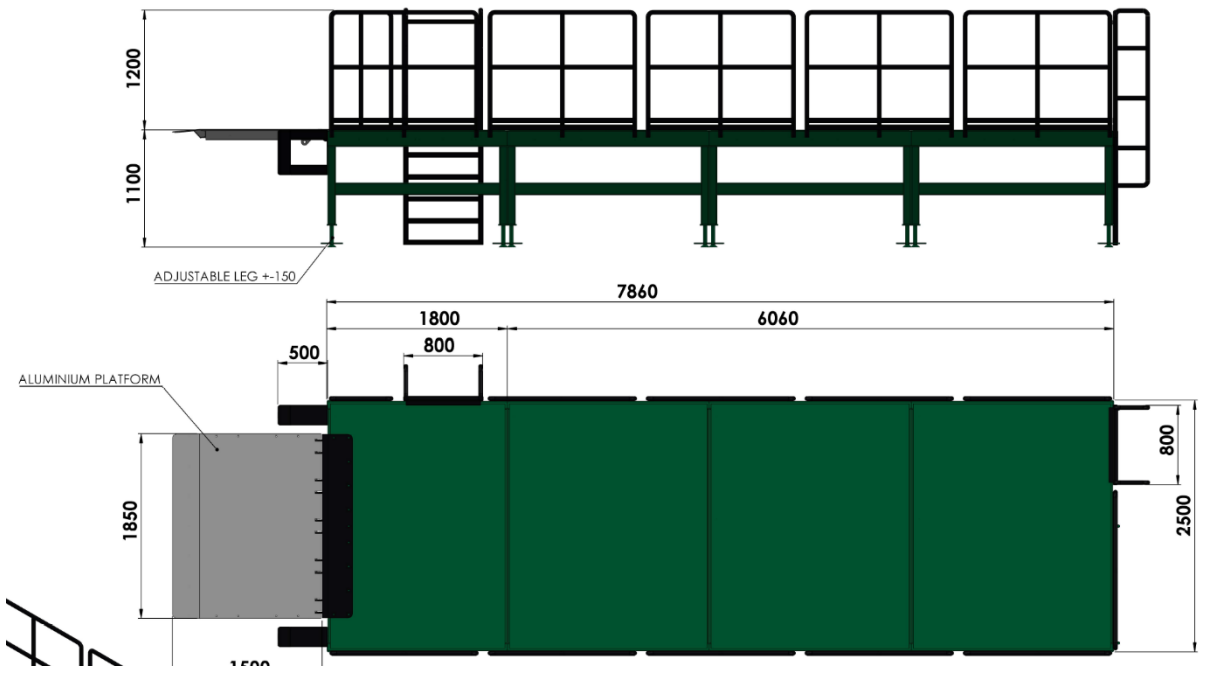

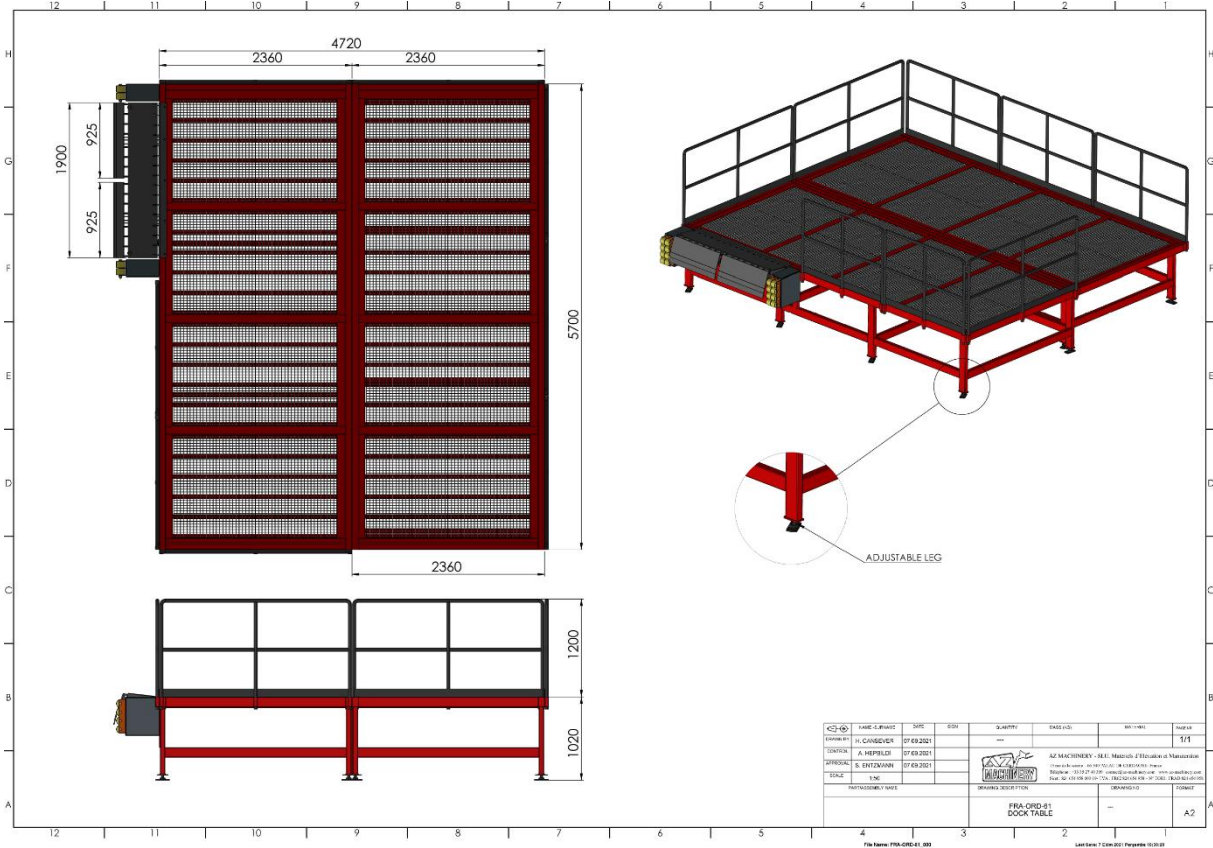
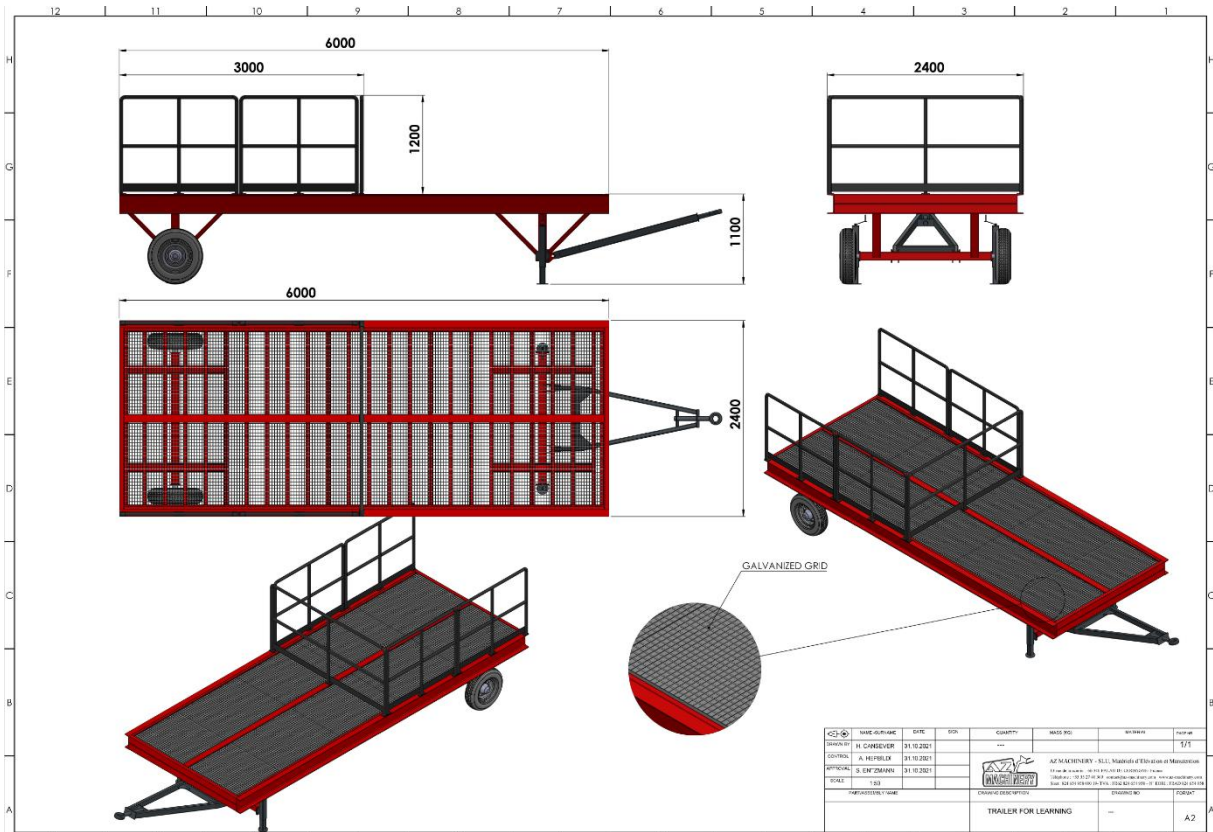

HYDRAULIC  
LEVELER

DETAIL B  
SCALE 1 : 15



DETAIL A  
SCALE 1 : 15

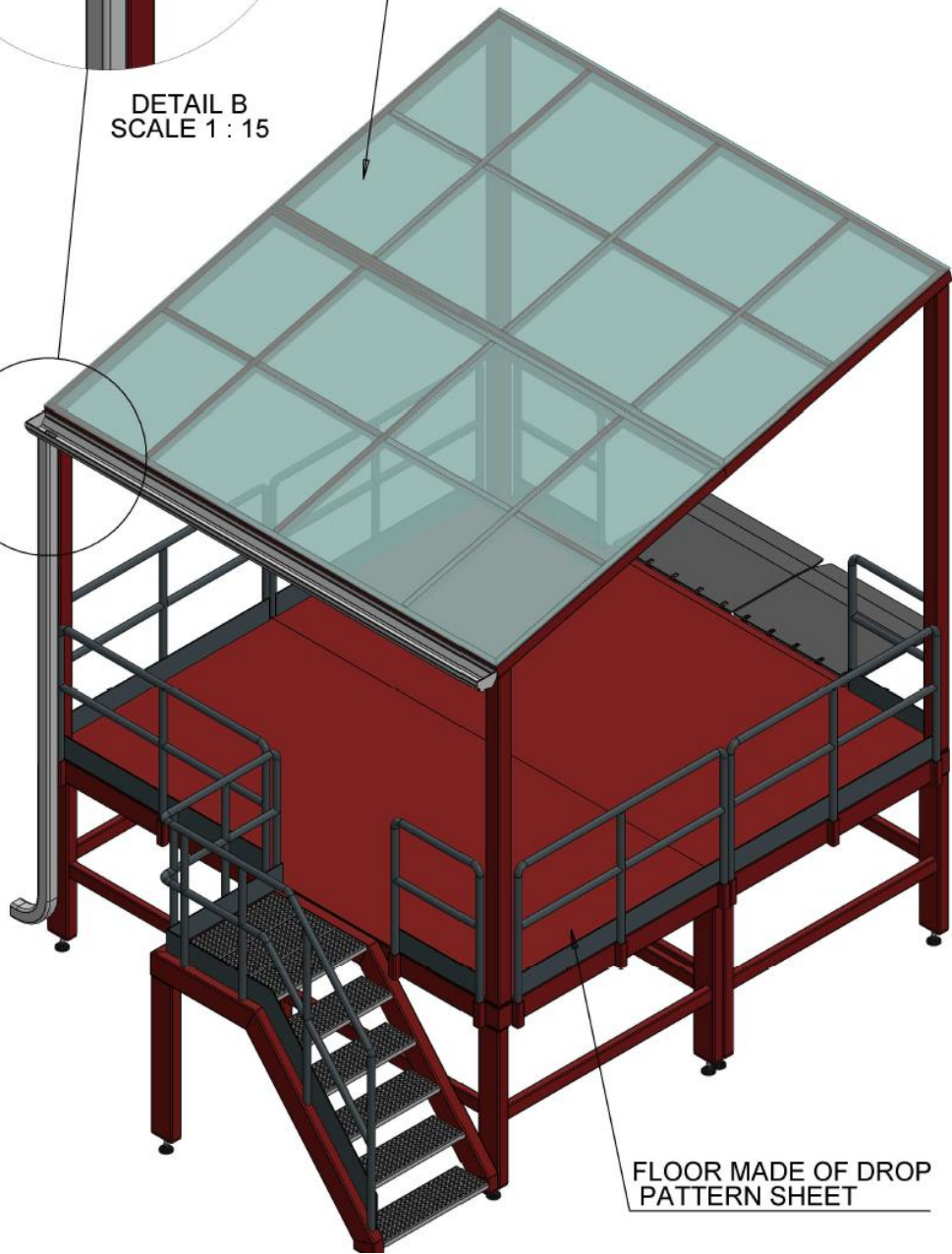

FLOOR MADE OF DROP  
PATTERN SHEET

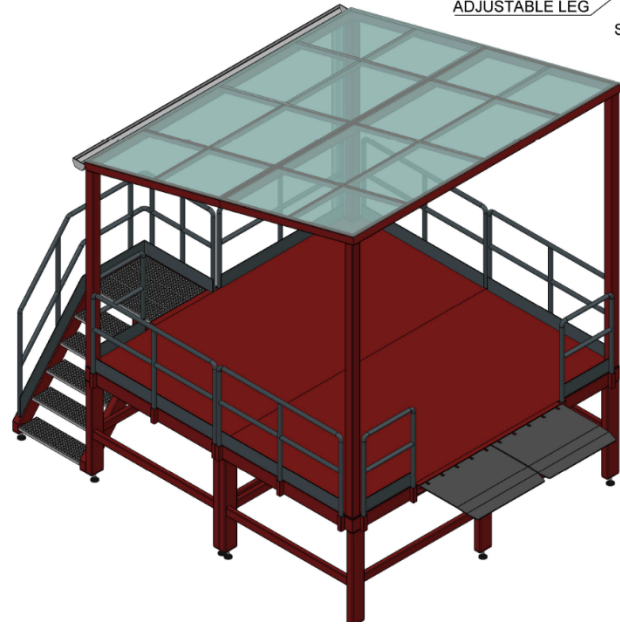
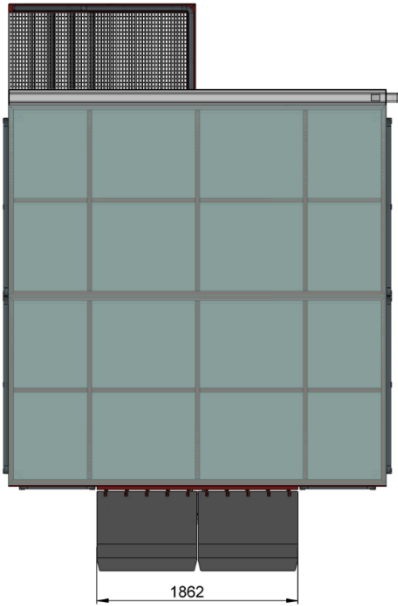
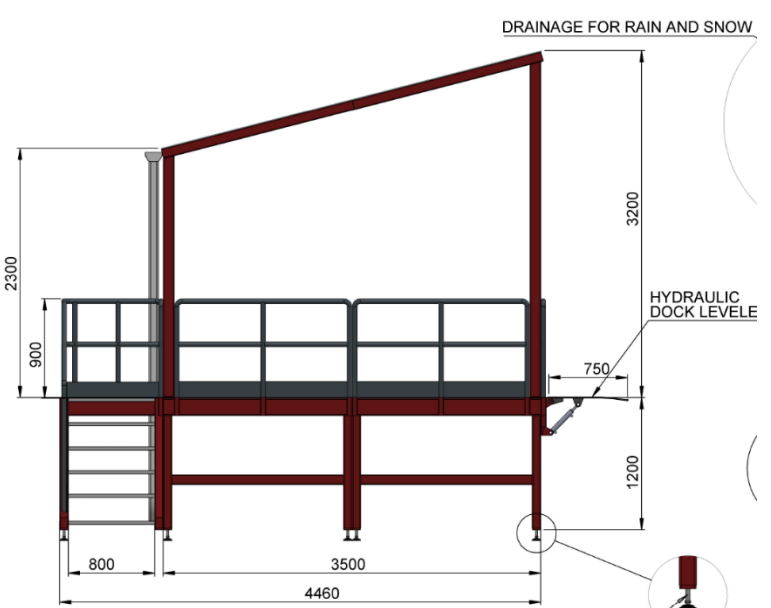
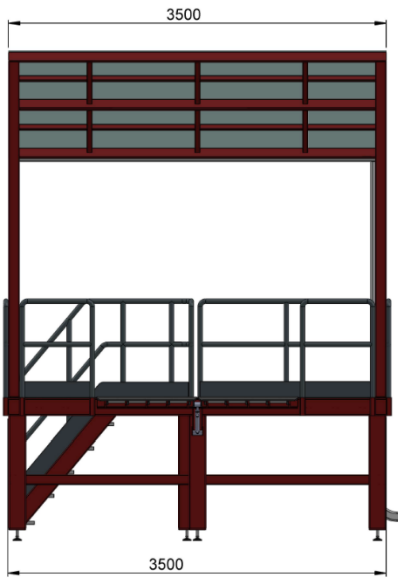

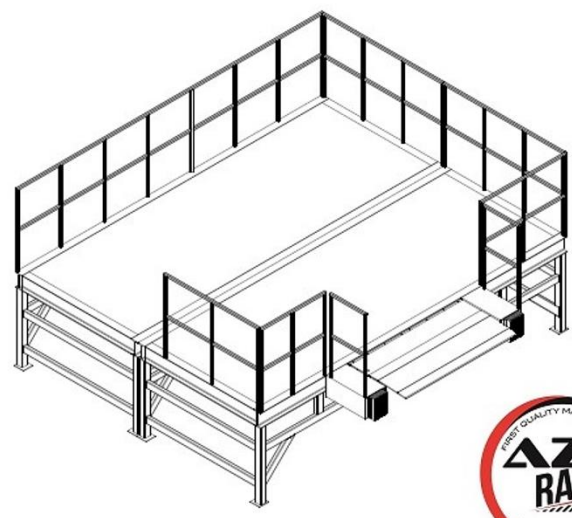
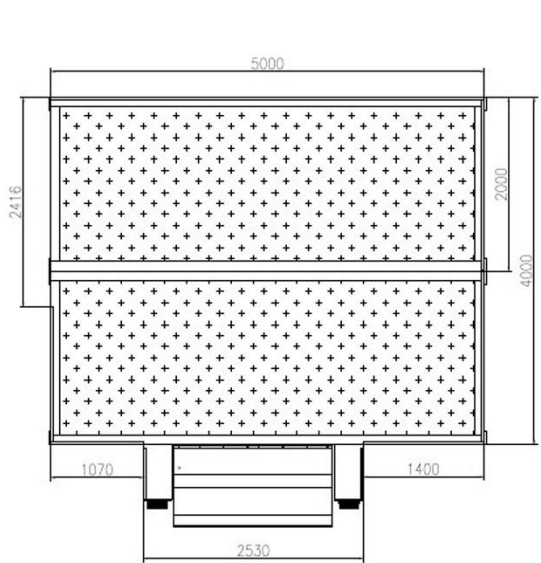
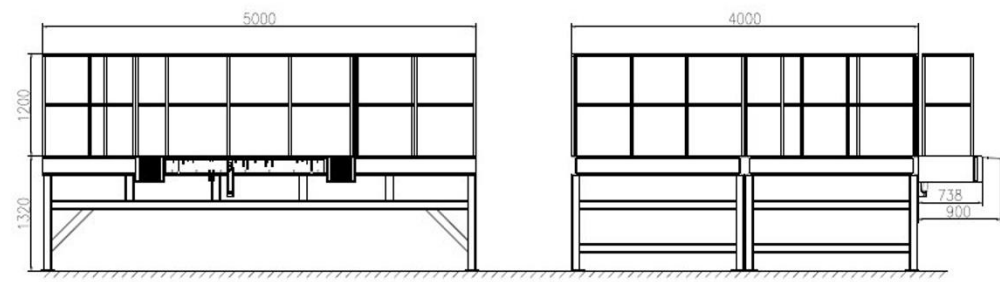
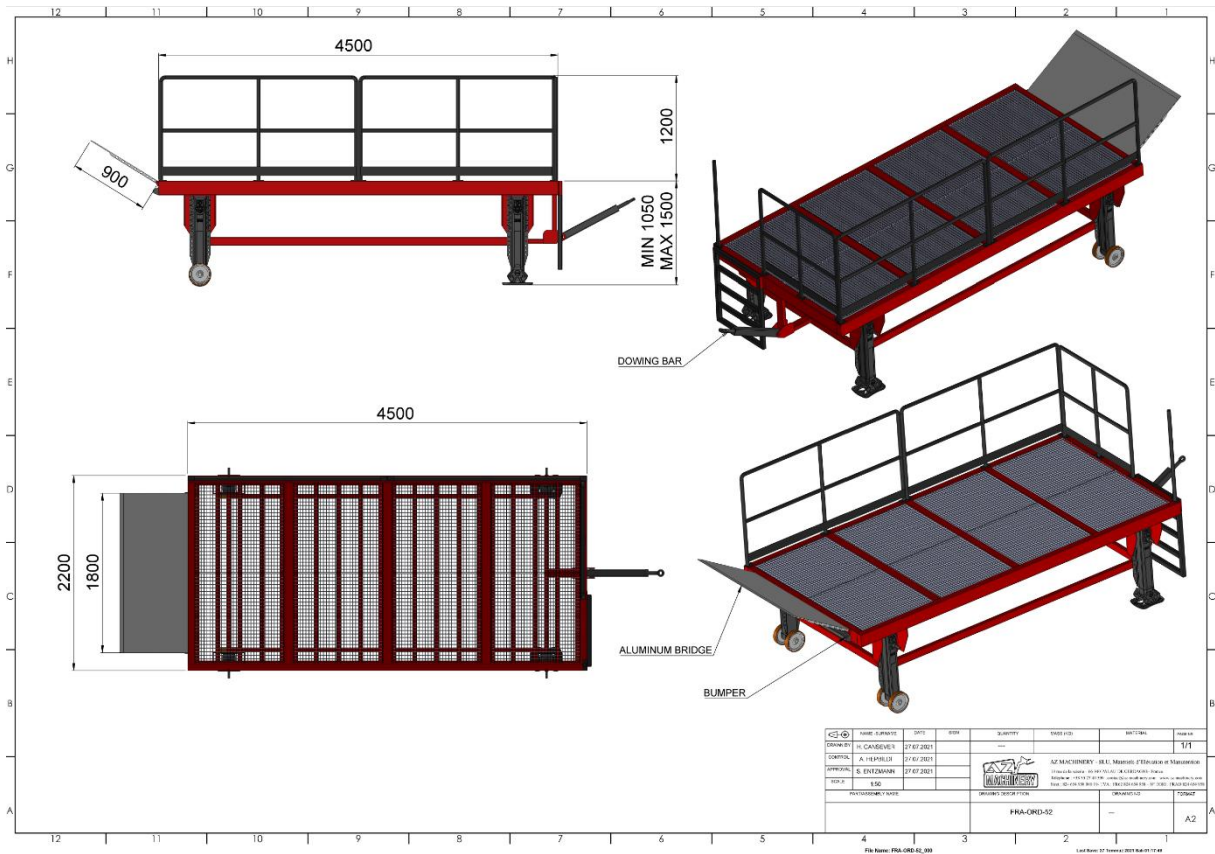

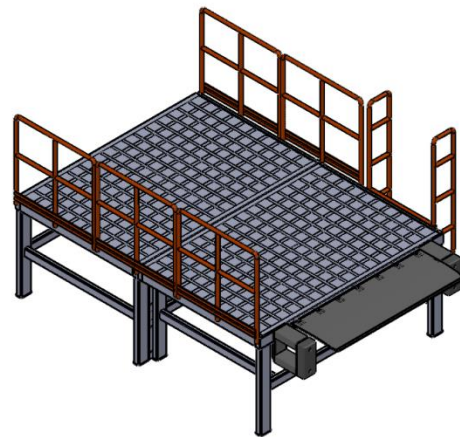
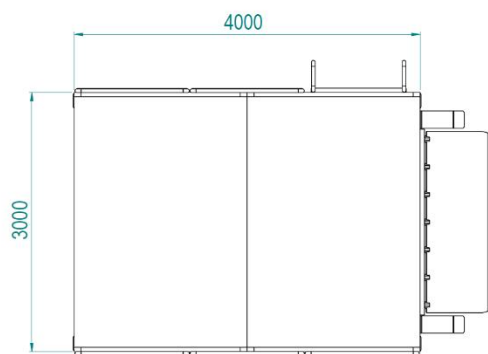
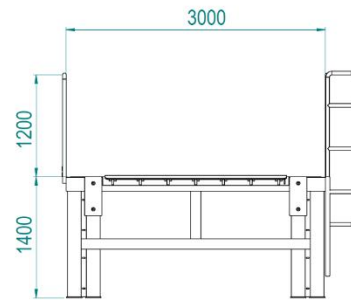
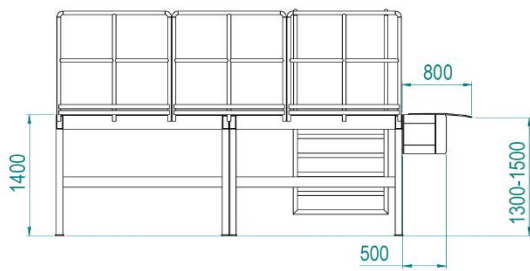
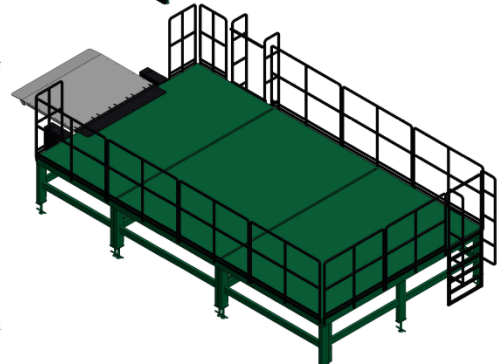
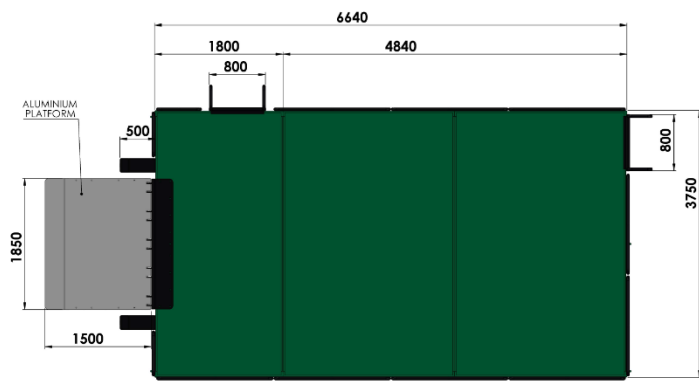
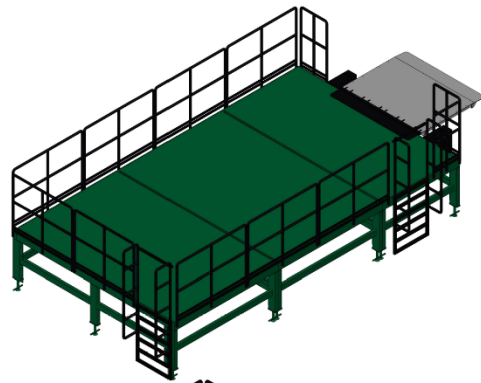
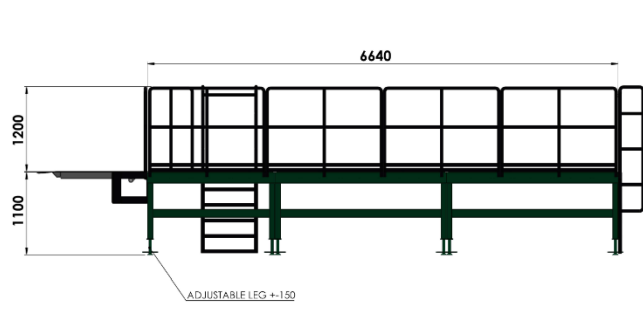

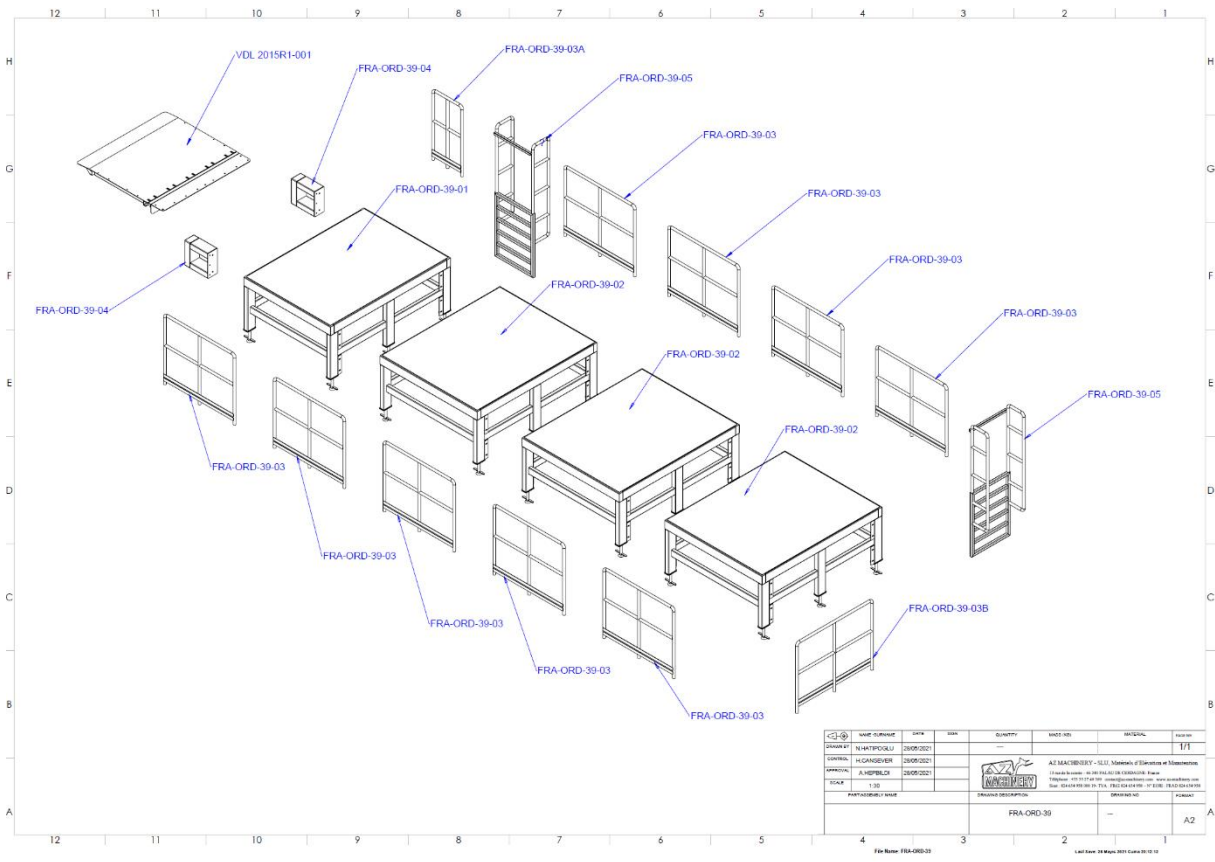
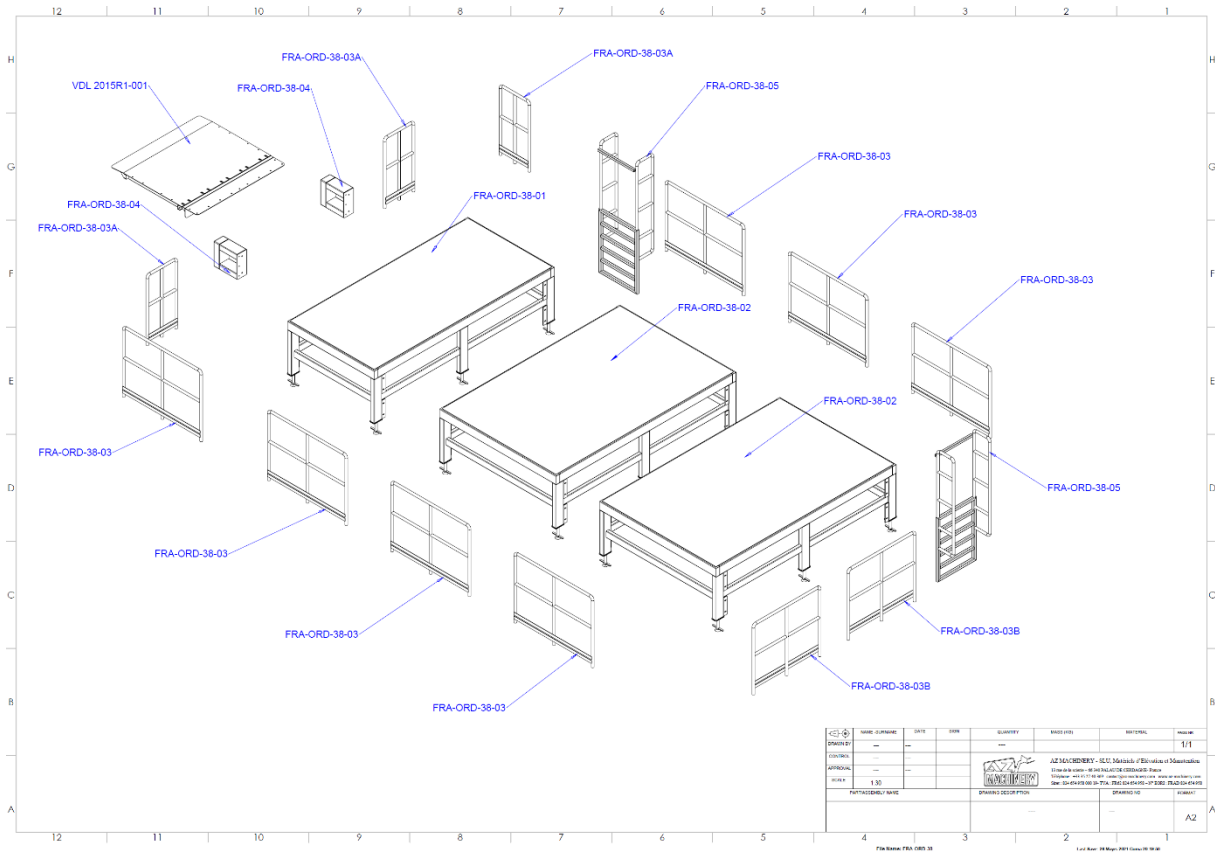



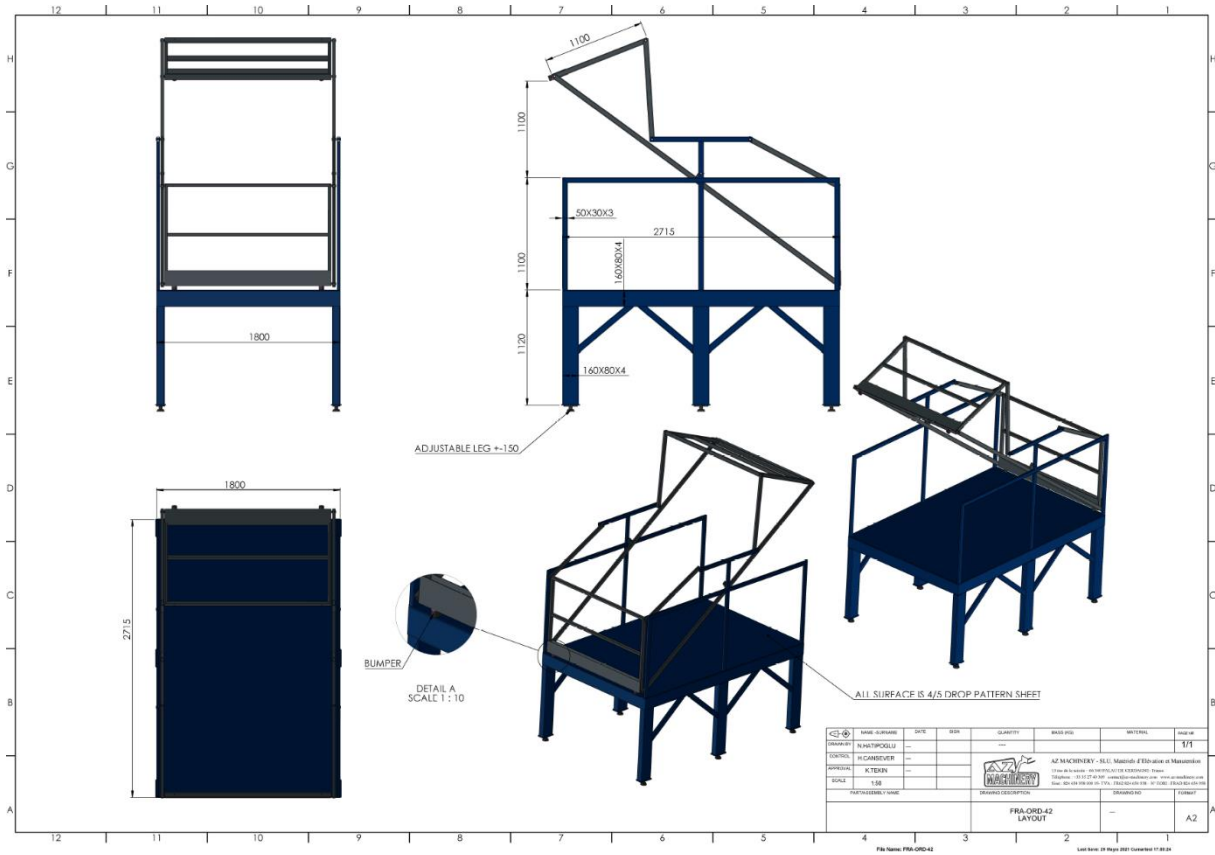
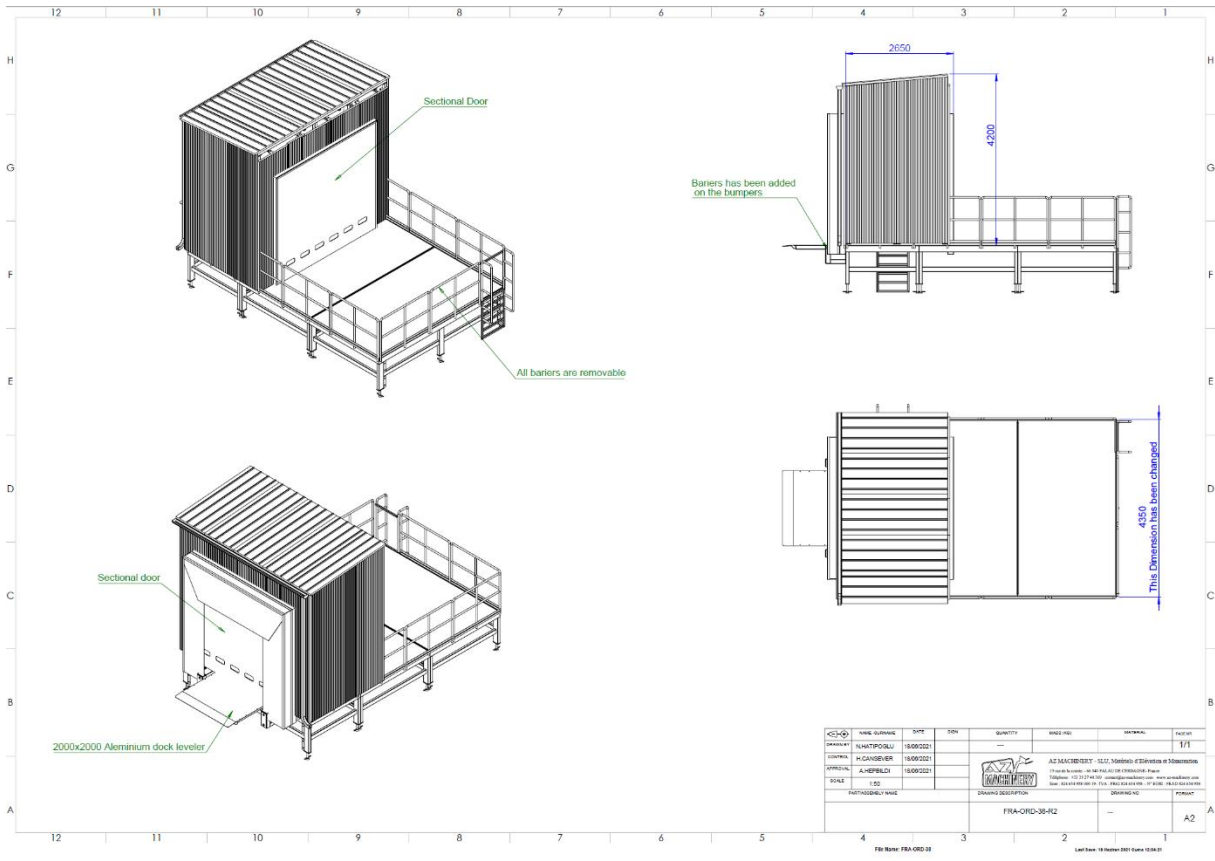

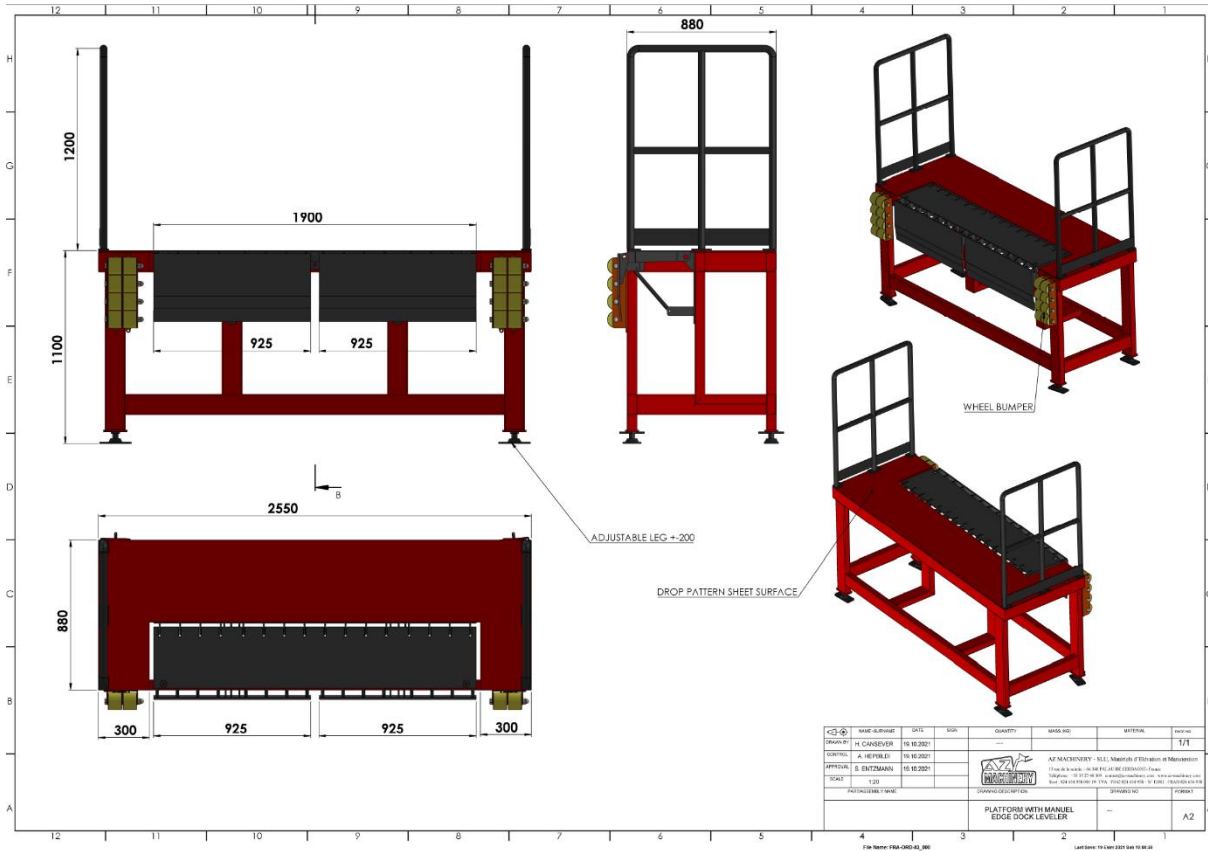
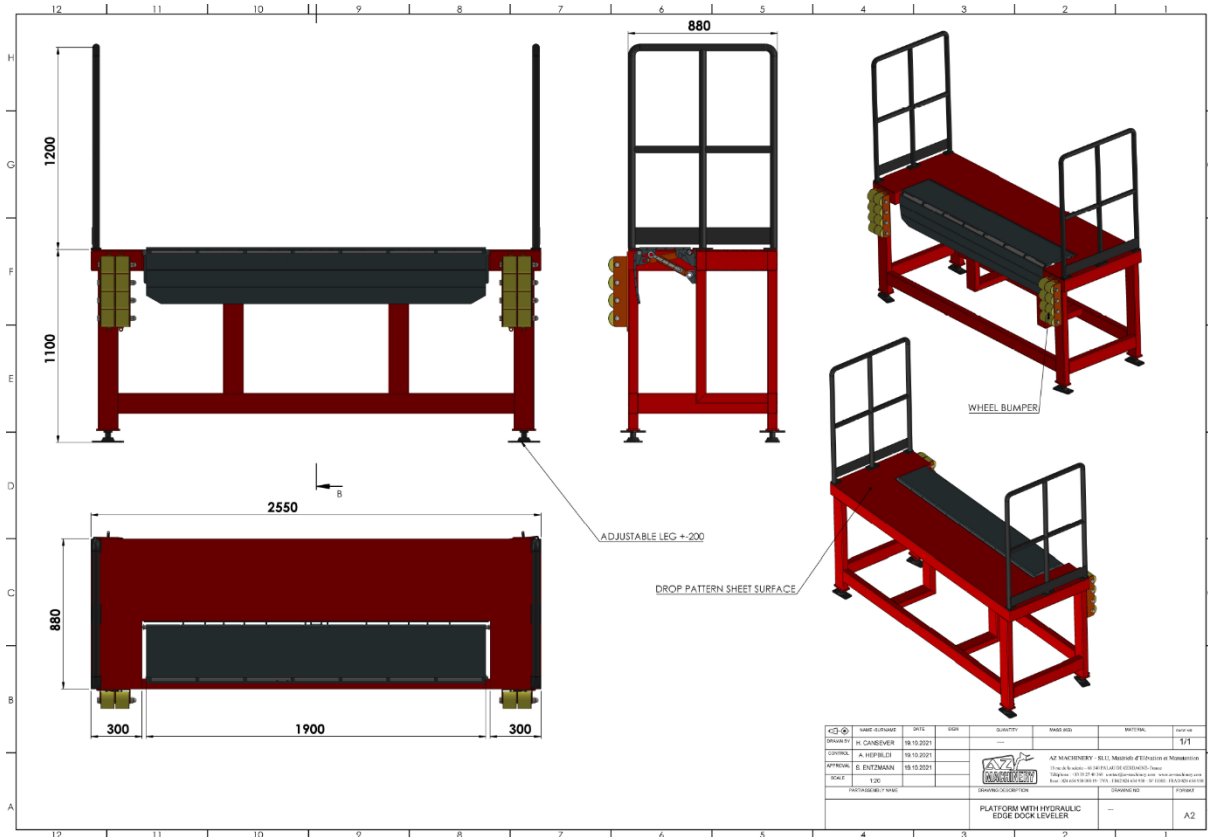

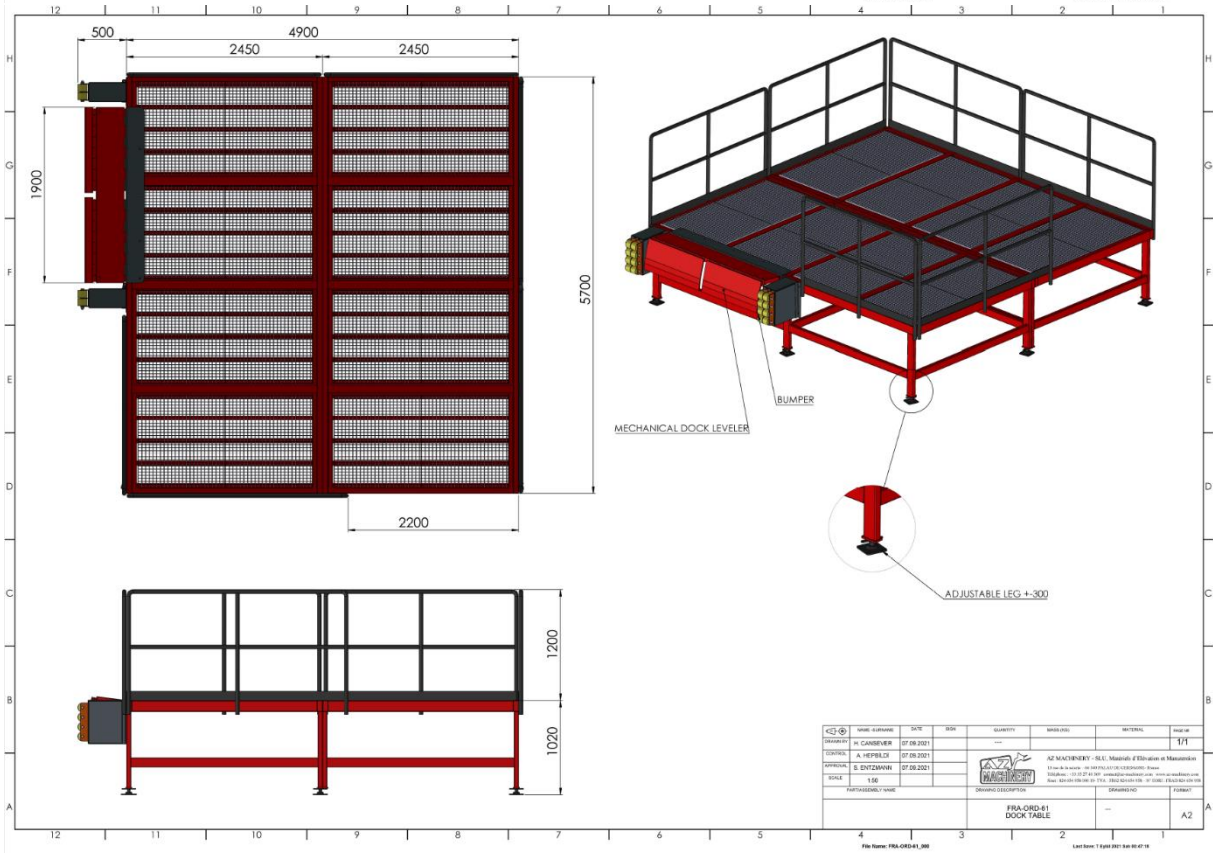
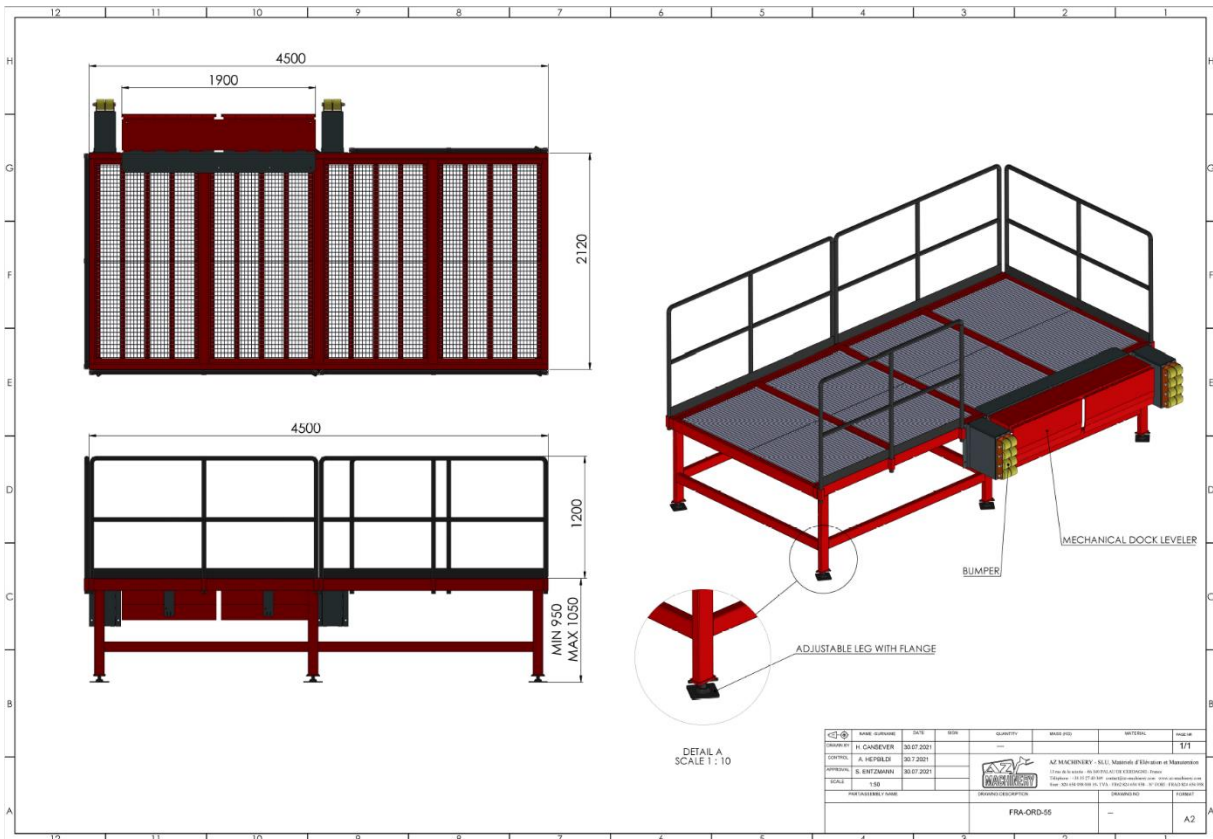

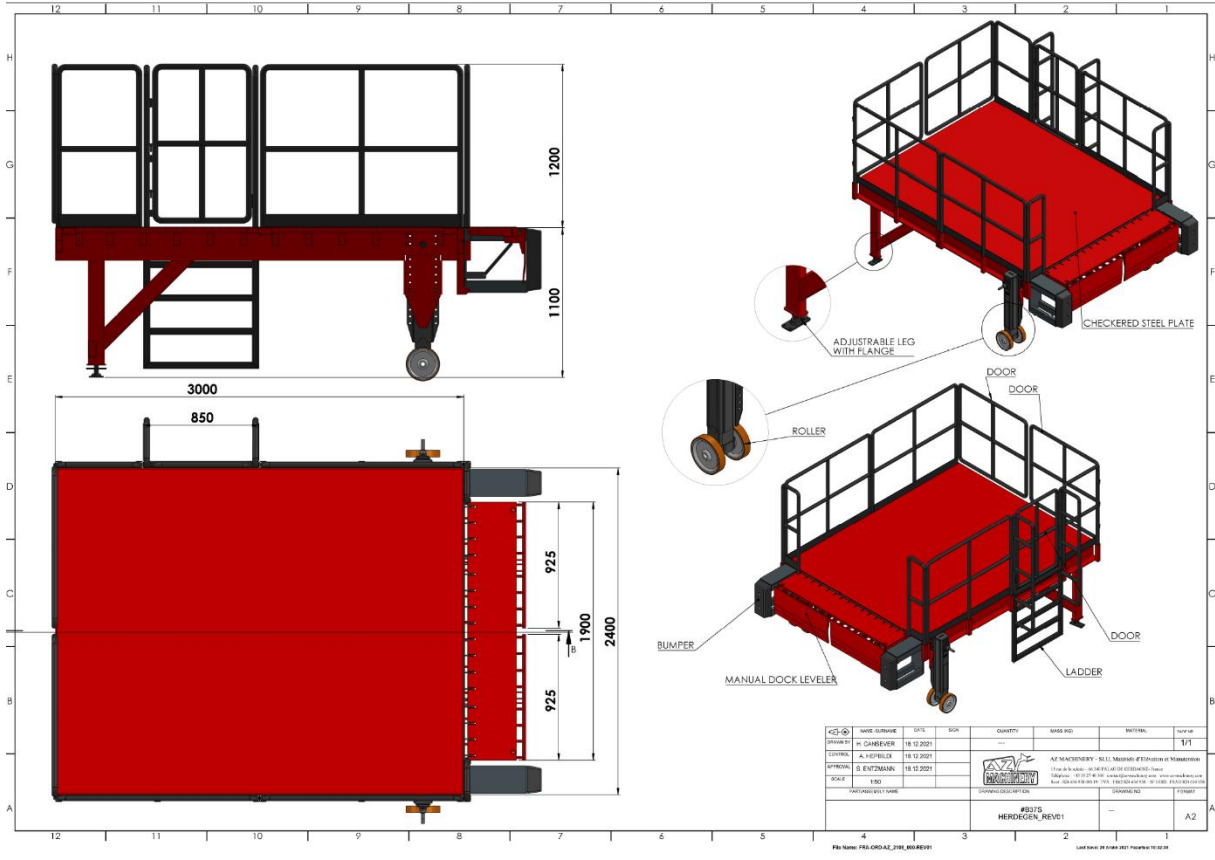
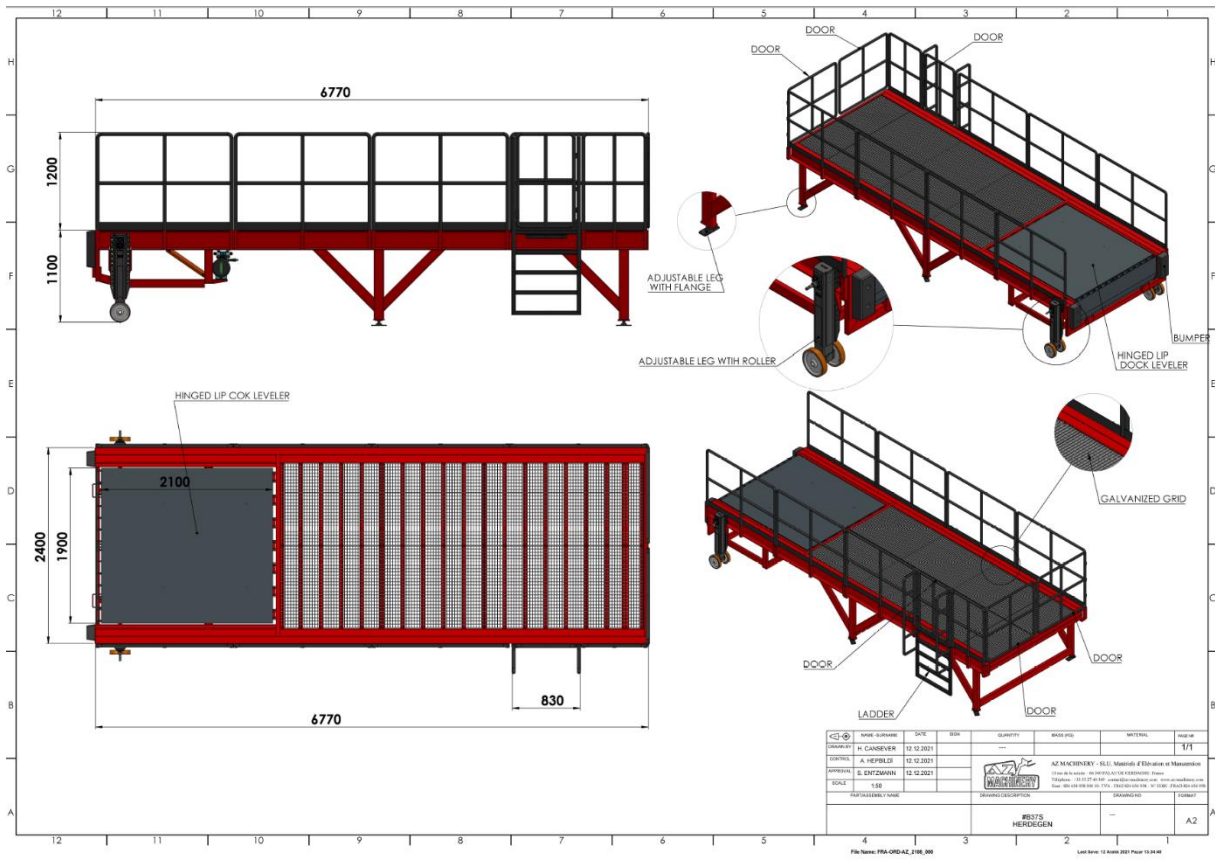

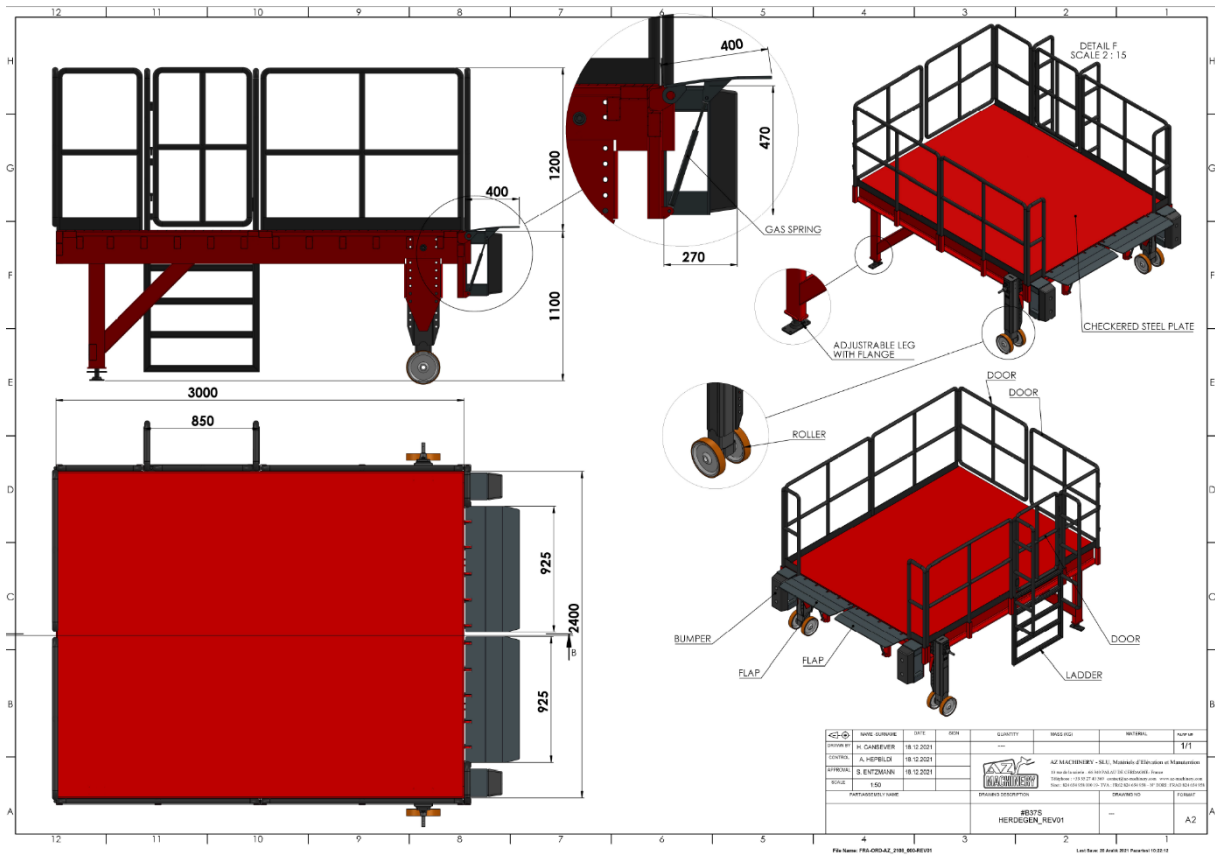

NO.	NAME	DATE	BY	QUANTITY	UNIT	REVISION	REASON
01	SK. GRABER	18.12.2021					
02	A. HEBEL	18.12.2021					
03	S. ENZMANN	18.12.2021					
04							
05							

	A2 MASCHINENBAU - S.G.L. Maschinen- & Elektro-Handwerk 10000 Herdogen, 10100 Herdogen, 10100 Herdogen 10000 Herdogen, 10100 Herdogen, 10100 Herdogen 10000 Herdogen, 10100 Herdogen, 10100 Herdogen
PROJEKTLEITER:	HERDEGEN_REV01
ZUSÄTZLICHE ANMERKUNGEN:	A2